

e-Series.
Built to do more.

From Universal Robots

e-Series

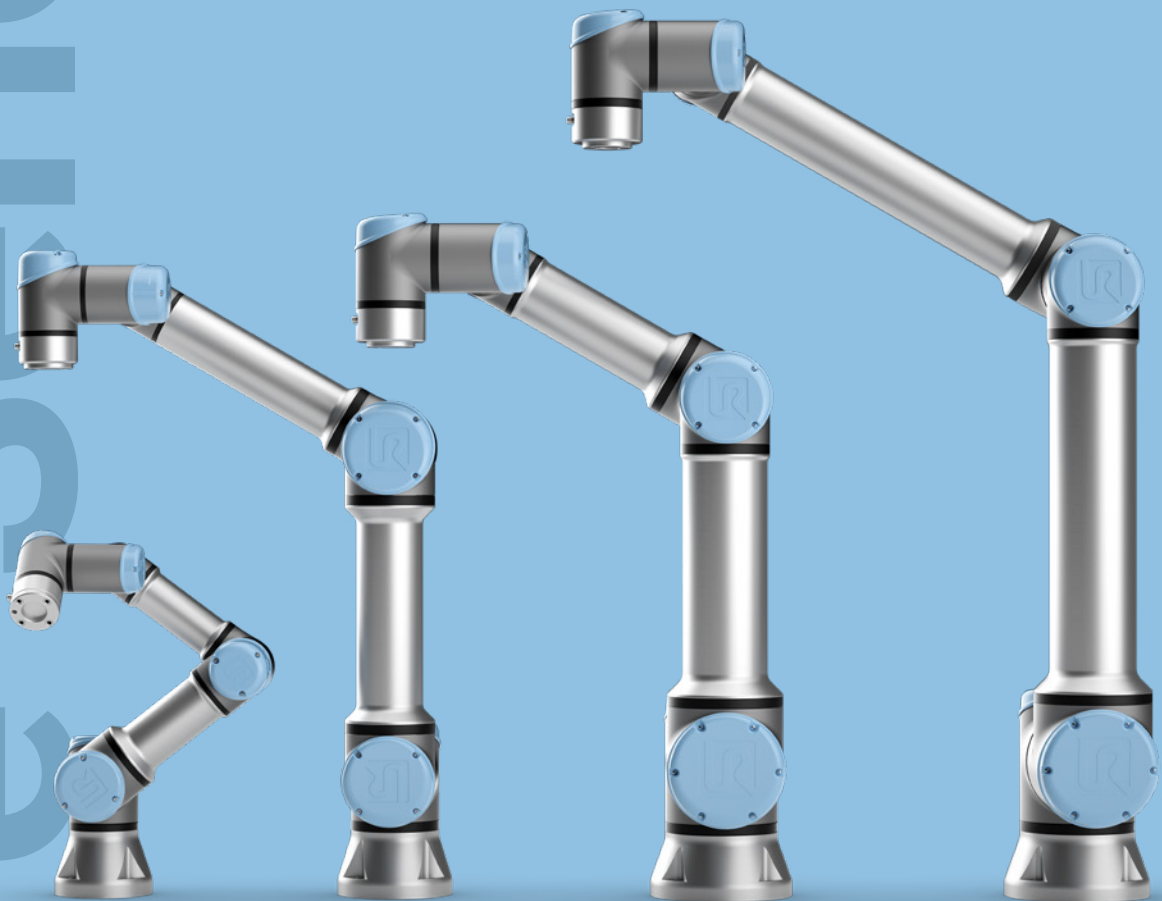

Collaborative robots can work almost anywhere and automate almost anything. They free people up to do what they're good at: creating, collaborating, and doing something amazing.

Collaborative robots, or cobots, expand capacity for businesses of all sizes. They can change the way employees work; integrate seamlessly with existing processes, layouts, and equipment; and improve quality across many applications. Collaborative automation makes the workplace safer and lets workers pursue more valuable tasks.

Many manufacturers overlook cobot automation because they think it brings the same challenges as old school traditional automation: huge cash outlays, disrupted factory floors, and complicated coding requiring specially trained personnel. The all-or-nothing approach of previous generations leads many plant managers and business owners to believe robot automation isn't accessible for their facilities.

Fortunately, this couldn't be further from the truth. In 2008, Universal Robots introduced the world's first commercially viable cobot arms, which differ from traditional industrial robots thanks to their small footprint, light weight, and ease of use. Automation is fast, flexible, and affordable thanks to collaborative robots.

In today's fast-changing manufacturing environment, cobots can help shops fill production orders faster, upskill their workers, and become more competitive. From packaging and palletizing, to machine tending, to assembling and welding, cobots can take on labor intensive tasks that leave staff free to deploy their expertise elsewhere.

Our e-Series range of collaborative robots is bringing automation's benefits to more businesses and industries than ever. This brochure will address the key e-Series technologies making manufacturers more productive, and how cobots overcome the top challenges facing manufacturing businesses of all sizes.



We know your industry has specific needs – let's help you exceed them.

[Explore successful cobot applications in your industry.](#)

>50k

Massive installed base

Universal Robots' 50,000+ cobot solutions have been deployed around the world in both tier 1 automotive suppliers and small machine shops, and thousands of facilities in between.

1/2

Simple to redeploy

Cobots can be reconfigured and programmed for a new task in as little as half a day.

90

Easy programming

After an online 90-minute course on [UR Academy](#), anyone can become a certified cobot programmer. There are even in-person classes for hands-on learning.

17

Collaborative-ready

The e-Series 17 standard adjustable safety functions effectively and easily mitigate risk in a work cell, following a risk assessment.

1

Quick payback

UR cobots routinely deliver payback within a year.

A collaborative solution for every need.

Meet the e-Series family.

The e-Series family has four members – the UR3e, UR5e, UR10e, and UR16e. Each cobot offers a different reach and payload, and they share the same ease of use and dependability that makes them a valuable addition to any production facility.

Subject to risk assessment, e-Series cobots can typically work alongside skilled operators on the production line, thanks to built-in configurable safety functions. Our cobots are certified by TÜV NORD for ISO 10218-1 and safety functions are rated as Cat.3 PL d according to ISO 13849-1. Safety is one of the pioneering features of collaborative robotics, and our users can meet demanding safety standards while exploring the unlimited applications of our cobots. Greater productivity, improved product quality, and peace of mind are ways we're making automation accessible to everyone.

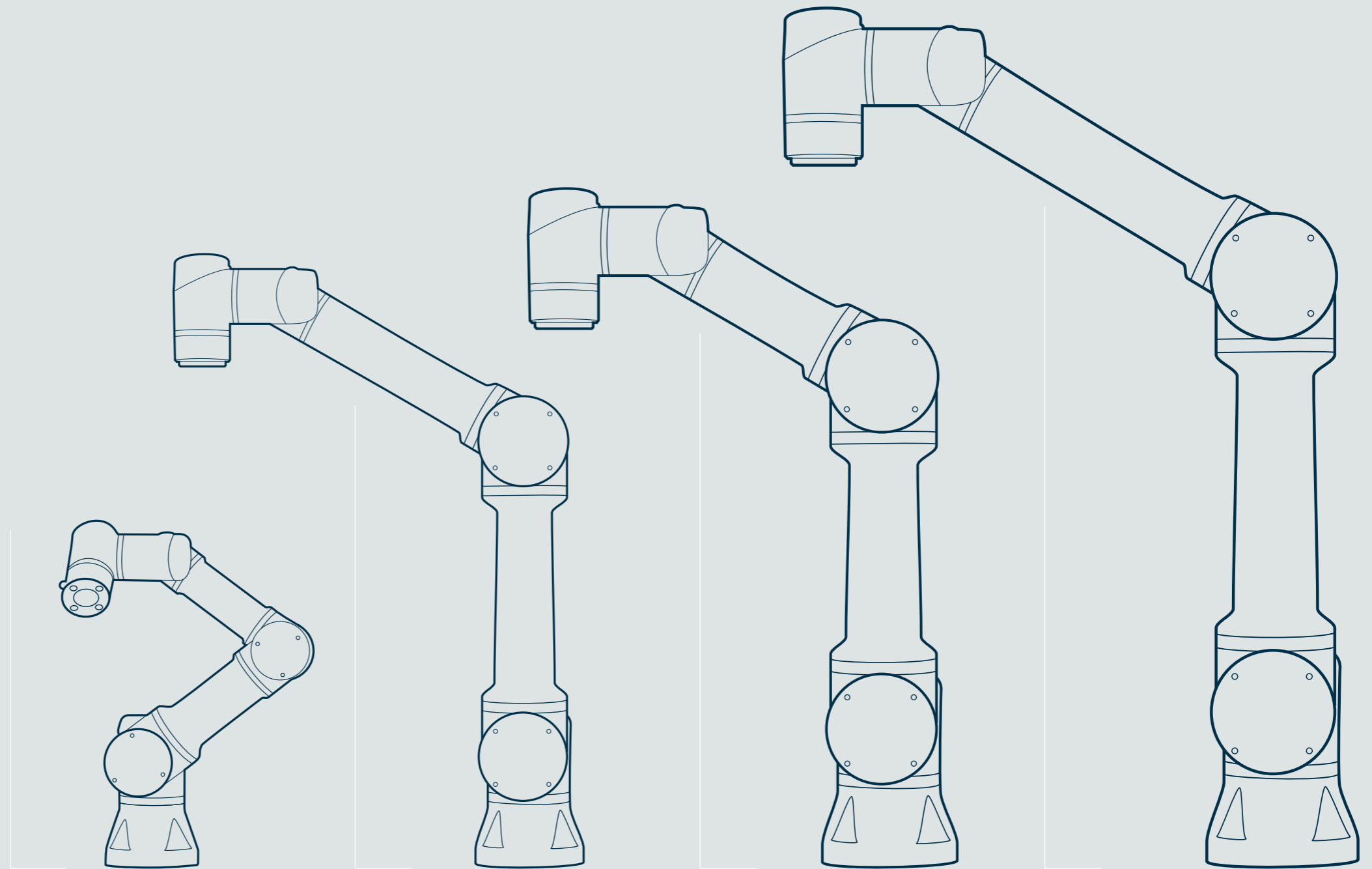

UR3e

Small but powerful, the UR3e has a payload of 3 kg and reach radius of 500 mm. With 360-degree rotation on all wrist joints and infinite rotation on the end joint, this table-top cobot handles high precision tasks and light assembly tasks with ease.

UR5e

The medium-sized member of the Universal Robots family is ideal for automating low weight processing tasks with its 5 kg payload and 850 mm reach radius. Easy to program and fast to set up, the UR5e strikes the perfect balance between size and power.

UR16e

With its 16 kg payload, the UR16e helps reduce the costs, ergonomic risks, and downtime associated with heavy part handling. A small footprint and 900 mm reach make the UR16e ideal for applications such as heavy-duty materials handling and CNC machine tending applications, including multi-gripper end of arm tooling.

UR10e

Capable of automating tasks up to 12.5 kg with the same reliability and performance characterized by the e-Series, the UR10e has a reach radius of 1300 mm. This enables it to carry out tasks like packaging and palletizing in facilities where there is a greater distance between different operating areas.

Robot arm specifications.

	UR3e	UR5e	UR10e	UR16e				
Specification								
Payload	3 kg (6.6 lbs)	5 kg (11 lbs)	12.5 kg (27.5 lbs)	16 kg (35.3 lbs)				
Reach	500 mm (19.7 in)	850 mm (33.5 in)	1300 mm (51.2 in)	900 mm (35.4 in)				
Degrees of freedom	6 rotating joints							
Programming	12 inch touchscreen with PolyScope graphical user interface							
Performance								
Power, Consumption, Maximum Average	300 W	570 W	615 W	585 W				
Power, Consumption, Typical with moderate settings (approximate)	100 W	200 W	350 W	350 W				
Safety	17 configurable safety functions							
Certifications	EN ISO 13849-1, PLd Category 3, and EN ISO 10218-1							
Force Sensing, Tool Flange	Force, x-y-z	Torque, x-y-z	Force, x-y-z	Torque, x-y-z				
- Range	30.0 N	10.0 Nm	50.0 N	10.0 Nm				
- Precision	2.0 N	0.1 Nm	3.5 N	0.2 Nm				
- Accuracy	3.5 N	0.1 Nm	4.0 N	0.3 Nm				
Movement								
Pose Repeatability per ISO 9283	± 0.03 mm		± 0.03 mm		± 0.05 mm		± 0.05 mm	
Axis movement	Working range	Maximum speed	Working range	Maximum speed	Working range	Maximum speed	Working range	Maximum speed
- Base	± 360°	± 180°/s	± 360°	± 180°/s	± 360°	± 120°/s	± 360°	± 120°/s
- Shoulder	± 360°	± 180°/s	± 360°	± 180°/s	± 360°	± 120°/s	± 360°	± 120°/s
- Elbow	± 360°	± 180°/s	± 360°	± 180°/s	± 360°	± 180°/s	± 360°	± 180°/s
- Wrist 1	± 360°	± 360°/s	± 360°	± 180°/s	± 360°	± 180°/s	± 360°	± 180°/s
- Wrist 2	± 360°	± 360°/s	± 360°	± 180°/s	± 360°	± 180°/s	± 360°	± 180°/s
- Wrist 3	Infinite	± 360°/s	± 360°	± 180°/s	± 360°	± 180°/s	± 360°	± 180°/s
Typical TCP speed	1 m/s (39.4 in/s)							
Features								
IP classification	IP54							
ISO 14644-1 Class Cleanroom	5							
Noise	Less than 60 dB(A)	Less than 65 dB(A)	Less than 65 dB(A)	Less than 65 dB(A)				
Robot mounting	Any Orientation							
I/O ports								
- Digital in	2							
- Digital out	2							
- Analog in	2							
Tool I/O Power Supply Voltage	12/24 V							
Tool I/O Power Supply	600 mA	1.5 A (Dual pin) 1 A (Single pin)	2 A (Dual pin) 1 A (Single pin)	2 A (Dual pin) 1 A (Single pin)				
Physical								
Footprint	Ø 128 mm	Ø 149 mm	Ø 190 mm	Ø 190mm				
Materials	Aluminium, Plastic, Steel							
Tool (end-effector) connector type	M8 M8 8-pin							
Cable length robot arm	6 m (236 in)							
Weight including cable	11.2 kg (24.7 lbs)	20.6 kg (45.4 lbs)	33.5 kg (73.9 lbs)	33.1 kg (73 lbs)				
Operating Temperature Range	0-50°C							
Humidity	90%RH (non-condensing)							



Upskill your workforce.
Uptime your business.

Our world-leading [Academy](#), [tailored service products](#) and [support suite](#) can help train your employees and maximize uptime.

System specifications.

A control box, teach pendant, and standard cable are included with every standard robot arm.

Control box

Features

IP classification	IP44
ISO 14644-1 Class Cleanroom	6
Operating Temperature Range	0-50°C
Humidity	90%RH (non-condensing)
I/O ports	
Digital in	16
Digital out	16
Analog in	2
Analog out	2
Quadrature Digital Inputs	4
I/O power supply	24V 2A
Communication	500 Hz Control frequency Modbus TCP PROFINET Ethernet/IP USB 2.0, USB 3.0
Power source	100-240VAC, 47-440Hz

Physical

Control box size (WxHxD)	460 mm x 449 mm x 254 mm (18.2 in x 17.6 in x 10 in)
Weight	12 kg (26.5 lbs)
Materials	Powder Coated Steel

Teach pendant

Features

IP classification	IP54
Humidity	90%RH (non-condensing)
Display resolution	1280 x 800 pixels

Physical

Materials	Plastic, PP
Weight including 1m of TP cable	1.6 kg (3.5 lbs)
Cable length	4.5 m (177.17 in)



PolyScope – our intuitive programming interface.

PolyScope offers users a high-level interface for very straightforward applications that any frontline operator can master. It also features a deep and complex programming environment for developers to pursue complex and experimental cobot applications.

Unboxing your UR cobot:

- 01 Robot arm
- 02 Control box
- 03 Teach pendant
- 04 Cable (available in 4 options)
- 05 Base flange connector

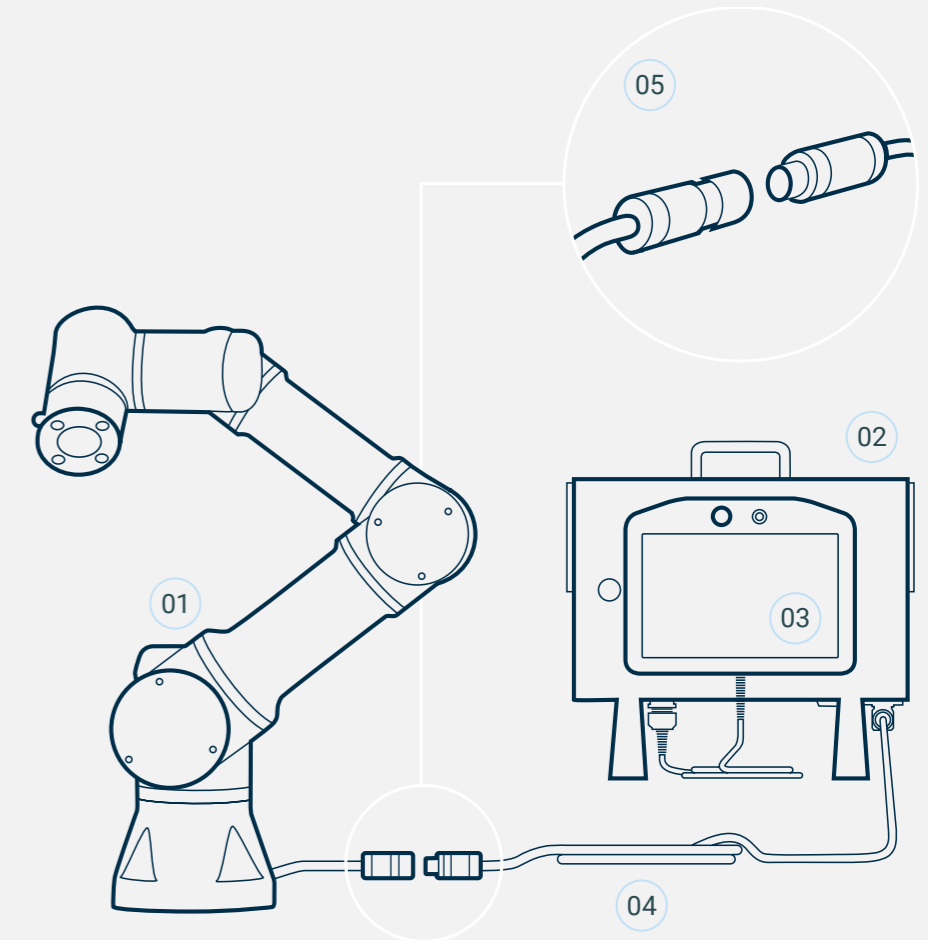

Every e-Series purchase includes a 6 m standard cable and a base flange connector that enables through-side and through-hole mounting for your robot.

The cable suite offers variants available for separate purchase that simplify the deployment of many common applications, like extending your range with a 12 m version of the standard cable. Also available is the High-Flex cable, designed to withstand more extensive and repeated bending. Making the right selection from the cable suite helps manufacturers tend multiple machines, weld larger workpieces, and in-crease pallet height with ease.

Cable suite

Specification	Standard*	Standard Extended**
Material	PVC	PVC
Color	Black	Black
Length	6 m (19.7 ft)	12 m (39.4 ft)
Diameter (d)	12.1 mm (0.48 in)	12.1 mm (0.48 in)

Specification	High-Flex**	High-Flex Extended**
Material	PUR	PUR
Color	Blue	Blue
Length	6 m (19.7 ft)	12 m (39.4 ft)
Diameter (d)	13.4 mm (0.53 in)	13.4 mm (0.53 in)
Bend Radius	4 x d (static) 8 x d (dynamic)	4 x d (static) 8 x d (dynamic)
Bend Cycle	5 million	5 million

* Included with robot purchase
** Separately sold accessory

The power to automate is in your hands.

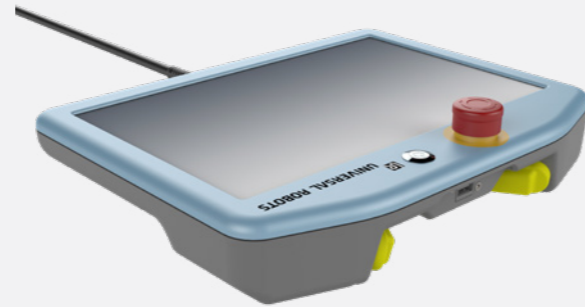

e-Series 3PE Teach Pendant

All e-Series cobots include the standard e-Series Teach Pendant, offering an intuitive user interface for easy programming with UR's powerful PolyScope software. A 3-position enabling teach pendant is also available as a variant for all payloads of e-Series robots, and as a UR+ component. The 3PE device is mechanically and functionally integrated with the e-Series Teach Pendant – just Plug & Produce with any e-Series control box. Additionally, it is fully integrated into the PolyScope user interface to enable all robot motion, including Freedrive, in manual mode.

Key Benefits

- Full mechanical 3PE device integration
- Full software integration - the 3PE Teach Pendant is natively supported in PolyScope
- Connects to the control box with the same connector as the standard e-Series teach pendant
- Can be mounted to any existing e-Series teach pendant brackets
- Includes two 3PE devices, allowing comfortable use with left or right hand
- Included in TÜV NORD certifications ISO 10218-1:2011 and ISO 13849-1:2015

Hardware Specifications

Width	300 mm (11.81 in)
Height	231 mm (9.09 in)
Thickness	50 mm (1.97 in)
Weight, including 1 meter of cable	1.8 kg (3.961 lbs)
IP Classification	IP54



Find the 3PE Teach Pendant and more Plug & Produce products on [Universal Robots+](#)

Your solution with UR built in.



e-Series OEM Control Box

Our standard control box complements the mobility and small footprint of our cobot arms. To meet the growing demand for cobots in sophisticated, purpose-built automation systems, we have developed a ready-to-integrate control box, designed to be embedded in another control panel. The minimal form factor of our OEM Control Box is powering complex automation systems, turnkey solutions, and OEM products, across many industries and applications.

The compact OEM control box is available with all sizes of e-Series robot arms, in AC or DC versions.

Key Benefits

- Cost effective
- Compact and lightweight
- No teach pendant or metal cabinet enclosure
- Reduces unneeded components and waste
- Power connector with strain relief included makes wiring easy
- Convenient mounting features
- AC model, like our standard robots, can be powered by a standard single-phase wall outlet
- DC model is ideal for battery-operated systems such as mobile robots

Hardware Specifications

OEM Control Box size (W×H×D)	451 mm × 168 mm × 150 mm (17.8 in × 6.6 in × 5.9 in)
Weight	AC model: 4.7 kg (10.4 lbs) DC model: 4.3 kg (9.5 lbs)
Input Voltage	AC model: 100–240 VAC, 47–440Hz DC model: 24–48 VDC (typical)
Standby power	AC model: <1.5 W DC model: <7 W

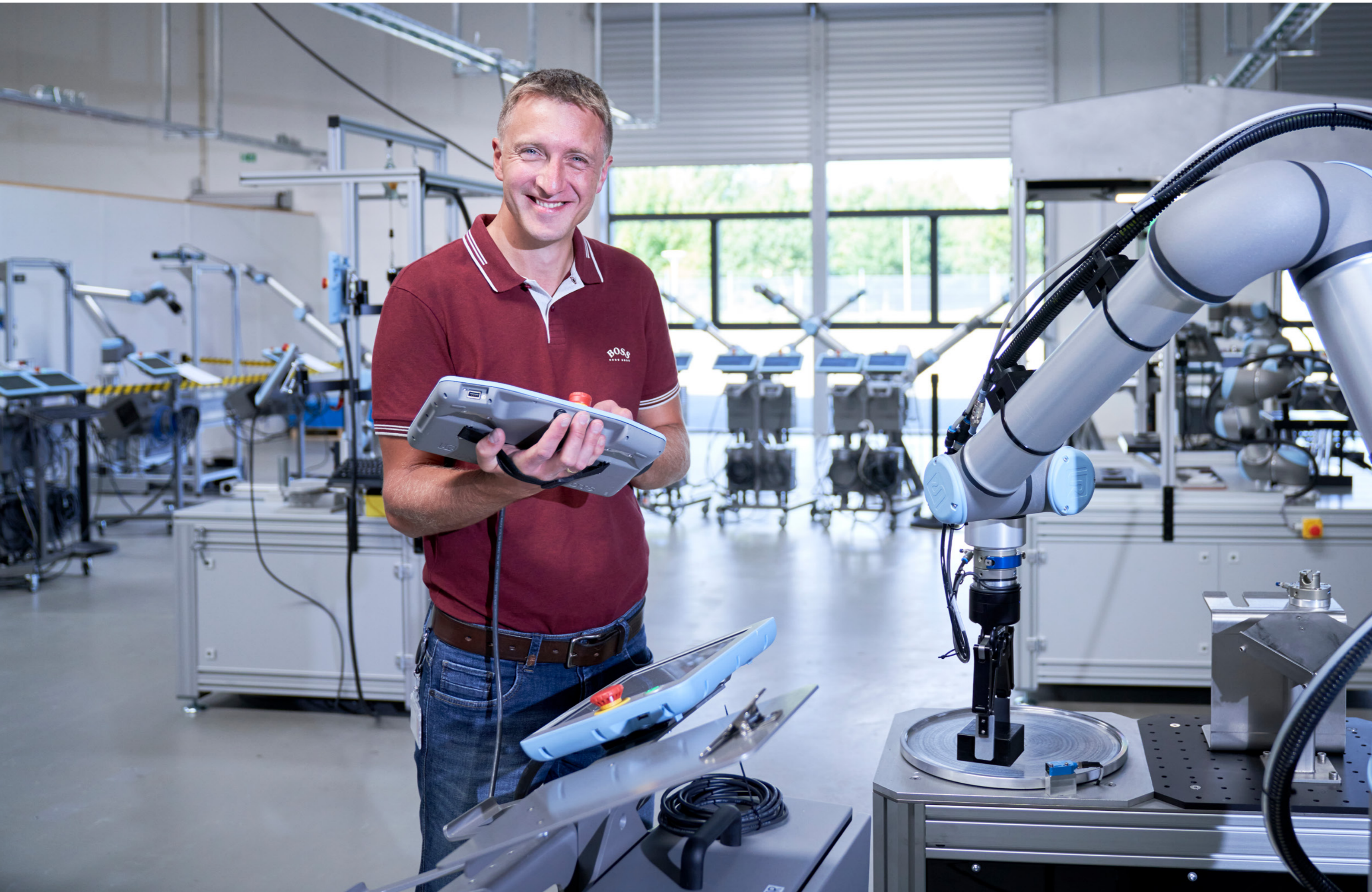

The e-Series is built to do more.

Universal Robots enables manufacturing companies of all sizes to reap the rewards of flexible automation, from increased throughput and improved part quality to increased capacity and greater competitiveness.

And just as Universal Robots allows small companies to access the benefits of automation, it inspires OEMs to reach out to a wider audience through technology development and the UR+ ecosystem. Our global team of automation engineers, applications experts, channel partners, and service support have deployed over 50,000 cobot systems around the world, and our tried and tested technologies are helping manufacturers do more with their businesses.

What's your reason for automating? Whether you're looking to build business capacity, increase your margin, or manage top-line growth, Universal Robots has designed the e-Series to turn your business problems into collaborative robot solutions.

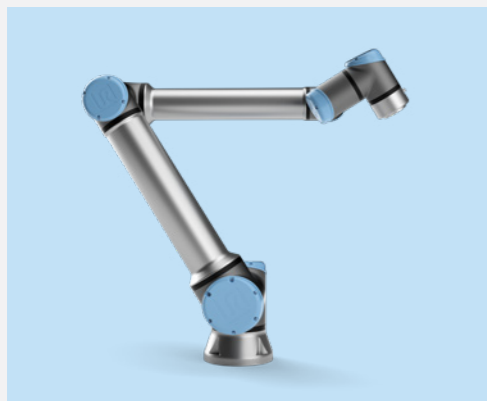

Tested and trusted collaborative robot technology.

About Universal Robots

Universal Robots is the market leader in collaborative robots. Since introducing the world's first commercially viable cobot in 2008, UR has developed a product portfolio including the UR3e, UR5e, UR10e, and UR16e, reflecting a range of reaches and payloads. Each model is supported by a host of Plug & Produce end effectors, software, and accessories in the UR+ certification program, allowing for flexible redeployment of one robot into several diverse applications.

Universal Robots has installed over 50,000 cobots worldwide automating every manufacturing industry.

Headquartered in Odense, Denmark, UR operates out of 21 regional offices in the Americas, Europe, and Asia-Pacific.







Contact

Triad Technologies
(800) 420-8575
985 Falls Creek Drive
Vandalia, OH 45377
www.triadtechnologies.com

Universal Robots USA, Inc.
(844) GO-COBOT
5430 Data Court, Suite 300
Ann Arbor, Michigan 48108
www.universal-robots.com



-  Facebook
-  LinkedIn
-  Twitter
-  YouTube
-  Instagram